

YASKAWA

U1000

Low Harmonics Regenerative Matrix Converter



A class of its own

The U1000 is a highly efficient AC drive based on latest matrix converter technology. With full power regeneration capability, the U1000 offers great energy saving potential while sinusoidal input currents and a power factor close to one reduce stress on grid components like transformers and power lines. With an ultra-compact shape, the U1000 is the first choice for innovative, energy-efficient drive solutions with or without power regeneration.





Innovative matrix technology

The U1000 can be used for standard and regenerative applications with the unique advantage of direct AC-to-AC power conversion. This unique design offers the best choice for induction motors (IM) and permanent magnet motors (PM). The U1000 benefits include a near unity power factor, increasing energy efficiency, enabling power regeneration and offering a very small footprint compared to conventional regenerative solutions. Moreover, the matrix converter can automatically switch the operation into bypass mode when running at grid frequency to reduce drive losses and motor noise.



Energy saving 4Q operation

Thanks to matrix technology the U1000 can operate fully regenerative. The matrix converter is your best drive for applications like crane, conveyor, winder, escalator, lift or test bench, where braking energy flow needs to be considered. The AC to AC design does not require any braking resistor which takes space in the cabinet and creates additional heat during regenerative time.



Functional safety built-in

U1000 has integrated SIL3 STO safety performance. The matrix converter complies with ISO/EN13849-1 Cat.3 PLe and IEC/EN61508 SIL3 (two safety inputs and one EDM output).



Costs saving

In addition to a reduction of energy consumption, the U1000 provides cost-saving benefits by a simplified installation and smaller panel requirements. The U1000 does not need any braking resistor which wastes the regenerative energy into heat.



Clean power

The sinusoidal input current with a total harmonic distortion of less than 5% and a displacement power factor of ~1 minimize losses in grid components like generators and transformers. This, at the same time, greatly reduces the potential of disturbance of other devices and improves the reliability of your system.



Time saving installation

As no external components like harmonic filters or AFD units are required, connecting a U1000 drive becomes a matter of minutes. 3 wires in, 3 wires out, no more. It cannot be easier to build up a low harmonic regenerative solution.



Low harmonic solution

The U1000 offers the best low harmonic solution in one unit. The matrix converter does not need any external harmonic filters to meet the IEEE 519 guideline and it offers a very compact size compared to other forms of harmonic mitigation at the same time.



Revolutionary design for low harmonics

The U1000 has a unique and innovative design which exceeds the performance of general-purpose AC drives. This pushes the best-in-class AC drive not only to improve the application performance but it also exceeds the IEEE 519 harmonic guideline for the power quality which helps you to keep the power supply clean from any pollution.

The benchmark product in low harmonic and regenerative applications

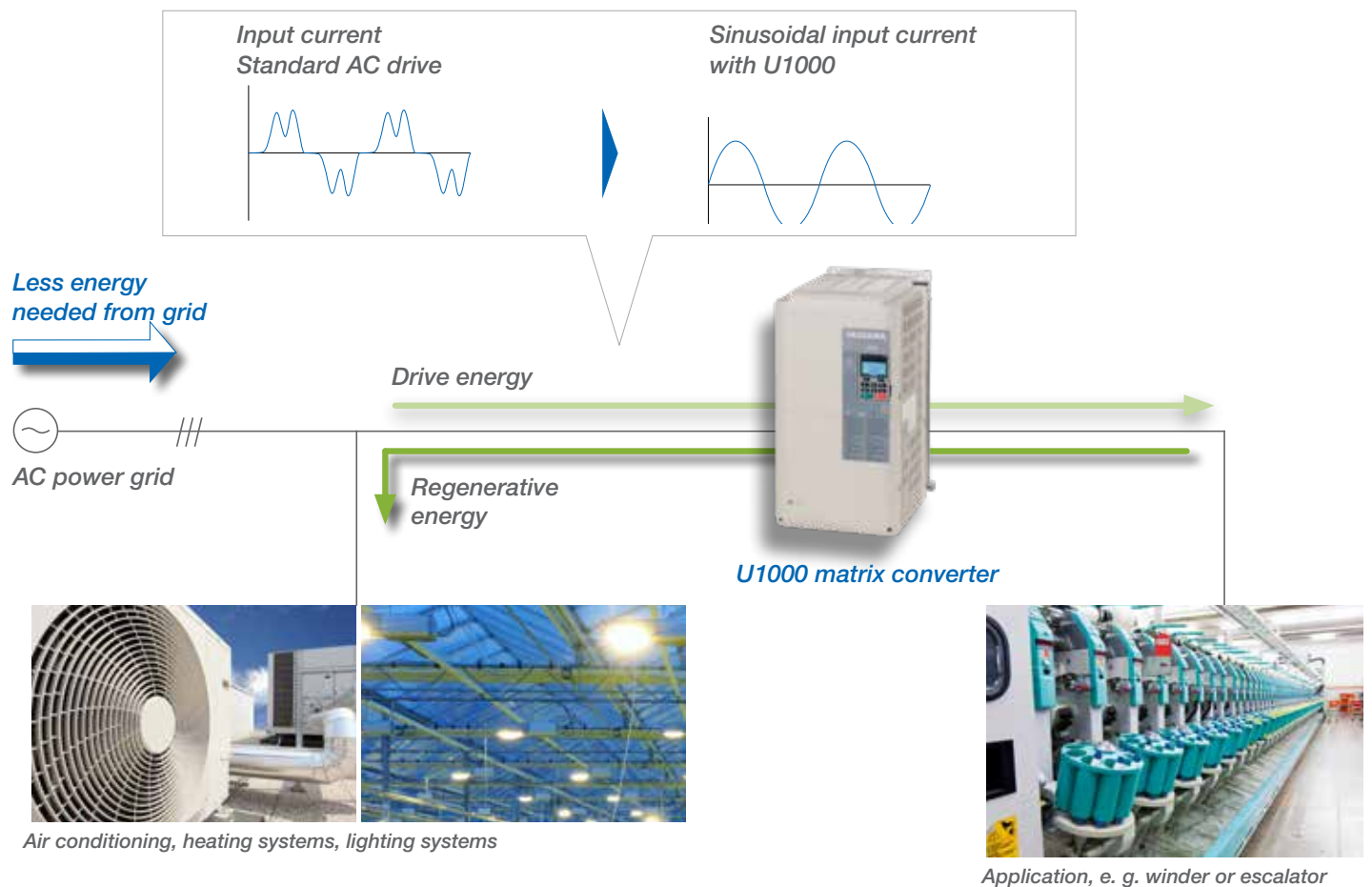

Winner of international awards

The milestone product for harmonic suppression, regenerative energy savings and space savings



Ultimate performance



U1000 is designed for rough applications. This extremely compact all in one solution offers optimum performance for standard and regenerative applications.

Regenerated power

The best-suited solution for regenerative applications. The U1000 eliminates the need to install external braking units and braking resistors. It returns the regenerative and the braking energy directly back to the power supply.

Built-in power regeneration

The U1000 is a very compact AC to AC drive, which means there is no DC bus inside. This innovative design does not need any braking resistor option which typically wastes the regenerative energy in heat. Now the regenerative energy can be used by other consumers in the same grid, saving total energy cost and consumption while also reducing the panel cooling system requirements.

- Saves energy
- Less heat generation, reduced need for ventilation
- No braking resistor - greatly reduced risk of fire
- Less maintenance
- Less parts
- Compact design

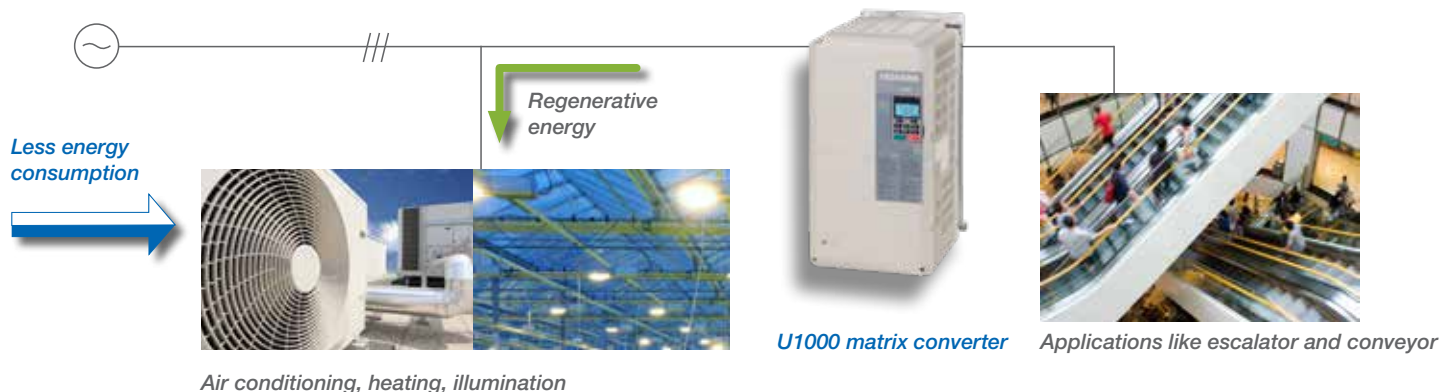

Compact and easy

The U1000 design advantages, compared to conventional dynamic braking solutions, continues in saving installation space (up to 50%), reduced weight and 100% save of wasted energy. All you need to connect is 3 wires in and 3 wires out.

- Smaller panels
- Very compact footprint
- Simple installation in shortest time
- Perfectly fits in existing installations - easy retrofit

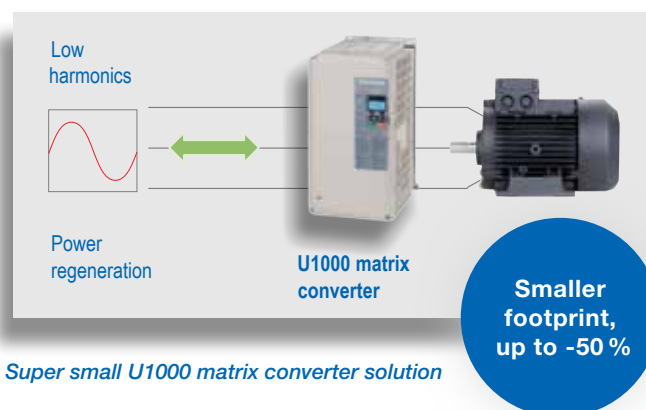
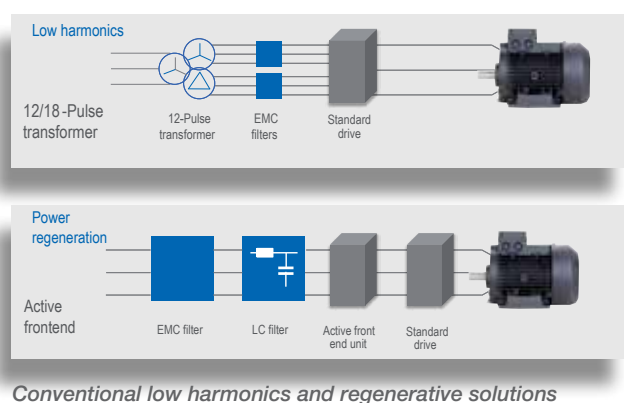

*Note: The U1000 is not designed for connection to the public power supply grid for commercial power generation.

Reliability and efficiency on board



BUREAU
VERITAS



ABS

ClassNK



Lloyd's
Register



DNV-GL



KR
KOREAN REGISTER

U1000 is approved for global marine installation. Compared to 12 pulse systems the Yaskawa matrix design provides significant footprint and weight savings, keeping the THDi within the IEEE 519 limits.

Clean currents





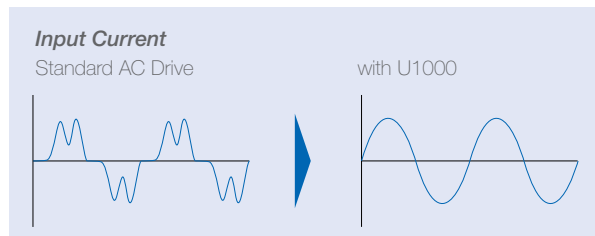

Clean power

U1000 is the answer to power quality, energy savings, and system efficiency improvement. The advanced technology of the Yaskawa matrix drive combines all application key features in a single space-saving drive design reducing THDi to 5% without the need for external transformers or heavy filtering.

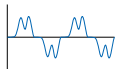
- No oversizing of transformers, generators or cables
- Sinusoidal input current and power factor at ~0.98
- Compact installation - 3 wire in, 3 wire in
- Reduced lifecycle cost
- Reliable operation
- 10 years of maintenance-free design

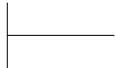

The ideal energy-saving solution for your application with U1000 regenerative converter unit

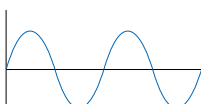
	Standard AC drive		88% Current distortion	0.75 Power factor
	Standard AC drive with DC reactor		33% Current distortion	0.9 Power factor
	12 pulse system with Standard AC drive		7 – 12% Current distortion	0.95 Power factor
	Matrix converter U1000		3 - 5% Current distortion	0.98 Power factor

Lift it up to the next level

The U1000 suits perfectly to lift and crane applications. The matrix drive eliminates the need to install external braking options and offers low harmonic and clean grid power performance in one unit design. Further, the U1000 comes with SIL3, PLe, Cat3 performance making easy integration into your safety system.

Compact efficiency

Eco mode - Built-in bypass function

The U1000 has a built-in bypass function. Whenever an application is matching the grid frequency, the U1000 can synchronize the motor to grid frequency. This built-in bypass function eliminates switching losses. It also nearly eliminates current distortion and the motor noise level will be significantly reduced.

- No need for external bypass components (no phase detectors, contactors, peripheral devices, ...)
- Reduced AC drive losses
- Silent motor operation



Conventional VFDs require external contactors to "bypass" the drive



Built-in automatic Bypass
(Synchronous transfer from VFD to Grid and vice versa)

System size reduction

Conventional dynamic braking solutions with braking units and braking resistors need lots of space and cooling. The U1000 matrix drive is a simple 3 wire in, 3 wire out configuration. This advantage in design reduces the footprint of your application, saving about 50 % on wiring and weight while also saving 100 % of wasted energy and eliminating the risk of fire by overheating the braking resistors.

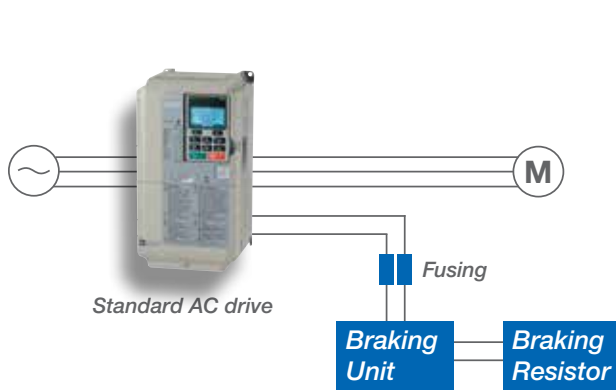

3 wire in - 3 wire out

Eliminate components

- No additional braking units
- No additional braking resistors
- No additional fusing

Reduce
Wiring by

50%

Reduce
Size by

70%

Reduce
Weight by

50%

Reduce **Wasted**
Energy by

100%

Sustainable solutions

A scenic landscape featuring a large, full-canopied green tree on a grassy hill. The foreground is filled with tall, yellow-green grass. In the background, rolling hills and a valley are visible under a bright blue sky with scattered white clouds.

The very compact footprint combined with low harmonic performance and reduced cooling requirement allows you to run the Yaskawa Matrix drive on smaller power grids and space critical installations.

Easy modernization

System efficiency

The AC to AC design of the matrix drive creates a sinusoidal input current. It means the U1000 provides a power factor close to 1. This near unity power factor makes it possible to reduce losses in generators, transformers, and cables. When installing the U1000 you can even design a smaller grid capacity for new installations or add more drives to existing power lines without additional stress to the power transformers.

**Power
factor:
0.98**

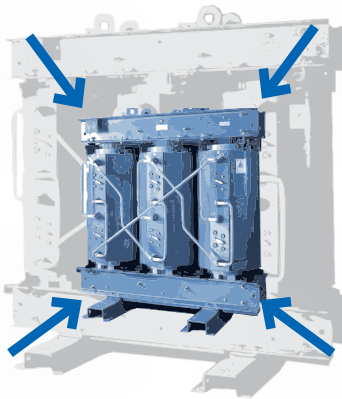

Significantly lower your system size when modernizing

Modernization

The Yaskawa matrix technology has been successfully proven in the field of low harmonic, space saving and regenerative applications. The direct AC to AC design advantage makes the setup more efficient and helps to save your operation cost sharing the regenerative energy with other electrical devices in the system.

- Low harmonic (keep IEEE 519 limits)
- No need for braking units and braking resistors or additional fusing
- Significant reduction in panel cooling requirements
- Easy conversion from an existing to a new system
- 100 % wasted energy saved
- Designed for 10 years of maintenance-free use

Built-in functional safety

U1000 comes with a built-in dual-channel safe torque off (STO) function that meets the requirements of SIL3 and PL-e, offering an easy way to improve machine safety without the need for complex external wiring.

- TÜV certified according to EN/ISO 13849-1 (PL-e), IEC 62061 (SIL3)
- Simple wiring
- Less components
- Higher reliability
- Space saving

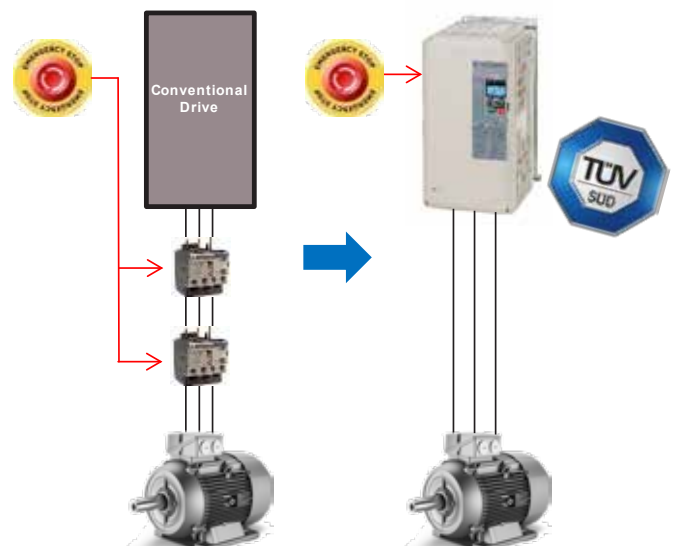

DriveWizard Plus for easy engineering

Manage the unique settings for all your drives right on your PC. An indispensable tool for drive setup and maintenance. Edit application parameters, access all monitoring parameters, generate customized process flows and monitor the performance of the AC drives using the oscilloscope function.



- Convenient PC-based drive-setup, monitoring and diagnostic functions
- Built-in oscilloscope function
- Automatic parameter conversion from older series drives
- Online and offline parameter editing

DriveWorksEZ for programming

DriveWorksEZ® provides users with programmable functions to customize U1000, GA500, GA700, V1000, and A1000 series AC drives to their specific applications without the need for external control systems such as PLCs. This allows users to easily access the drives via a symbol-based graphical programming environment.

- PLC or other controllers not necessary
- Easy to use
- Fast and constant scan cycles
- Flexible
- Online monitoring
- Process control
- Protected application know-how

Examples

Economically optimized water skiing facility

- No additional I/Os necessary
- No PLC required - reduced the system cost to less than 50 % of the initial estimate

Highly precise positioning

- Direct access to encoder pulses
- User-defined units and monitors

Further examples

- Efficient brake sequence
- Unbalance detection in washing machines

For a wide range of applications



- Elevators, lifts, escalators
- Centrifuges, winders, downhill conveyors
- Cranes, hoists

- Saws, large fans, machine tool spindles
- Presses, dryers, vibratory equipment
- and many other applications

Technical specification

Power ratings

Three-phase, 400 VAC

AC drive model CIMR-U□4□	0011	0014	0021	0027	0034	0040	0052	0065	0077	0096	0124	0156
Input current [A] ^{*1} (ND Rating)	10	13	19	25	31	36	47	59	70	87	113	142
Rated input capacity [kVA] ^{*2} (ND rating)	9	12	17	22	28	33	43	54	64	80	103	130
Rated output current (100 % ED) [A] ^{*3,4}	11	14	21	27	34	40	52	65	77	96	124	156
Overload tolerance ^{*6}	HD rating: 150 % of rated output current for 60 s ND rating: 120 % of rated output current for 60 s (Derating may be required for applications that start and stop frequently)											
Carrier frequency	4 kHz (User adjustable up to 10 kHz. Derating may be required.)											
Max. output voltage [V]	Proportional to input voltage ^{*5,7}											
Max. output frequency [Hz]	400 Hz (User-adjustable)											
Rated voltage / Rated frequency	Three-phase (CIMR-U□4□□□□) 380 to 480 VAC 50/60 Hz											
Allowable voltage fluctuation	-15 to +10 %											
Allowable frequency fluctuation	±3 % (Frequency fluctuation rate: 1 Hz/100 ms or less)											
Allowable phase power supply voltage unbalance	2 % or less											
Harmonic current harmonic distortion ^{*5}	5 % or less (IEEE519 compliant)											
Input power factor	0.98 % or more (During rated operation)											

AC drive model CIMR-U□4□	0180	0216	0240	0302	0361	0414	0477	0590	0720	0900	0930
Input current [A] ^{*1} (ND rating)	164	197	218	275	329	377	434	537	655	819	846
Rated input capacity [kVA] ^{*2} (ND rating)	150	180	200	251	300	344	396	490	598	748	773
Rated output current (100 % ED) [A] ^{*3,4}	180	216	240	302	361	414	477	590	720	900	930
Overload tolerance ^{*6}	HD rating: 150 % of rated output current for 60 s ND rating: 120 % of rated output current for 60 s (Derating may be required for applications that start and stop frequently)										
Carrier frequency	4 kHz (User adjustable up to 6 kHz. Derating may be required.)						3 kHz				
Max. output voltage [V]	Proportional to input voltage ^{*5,7}										
Max. output frequency [Hz]	400 Hz (User-adjustable)										
Rated voltage rated frequency	Three-phase (CIMR-U□4□□□□) 380 to 480 VAC 50/60 Hz										
Allowable voltage fluctuation	-15 to +10 %										
Allowable frequency fluctuation	±3 % (Frequency fluctuation rate: 1 Hz/100 ms or less)										
Allowable phase power supply voltage unbalance	2 % or less										
Harmonic current harmonic distortion ^{*5}	5 % or less (IEEE519 compliant)										
Input power factor	0.98 % or more (During rated operation)										

*1 Assumes operation at the rated output current. Input current rating varies depending on the power supply transformer, input reactor, wiring connections, and power supply impedance.

*2 Rated input capacity is calculated with a power line voltage of 480 V × 1.1.

*3 The rated output current of the drive output amps should be equal to or greater than the motor rated current.

*4 Carrier frequency is set to 4 kHz. Current derating is required to raise the carrier frequency.

*5 If the harmonic current distortion is needed to be 5 % or less, the maximum output voltage = [input voltage] × 0.87.

*6 Heat stress generated from repetitive high current that exceeds 150 % of the rated output current can shorten the life span of the IGBTs.

*7 The maximum output voltage = [input voltage] × 0.92.

*8 C7-60 (Output Voltage Limit Mode Selection) is set to 1 (Harmonic Suppression Priority Mode).

Power ratings, continued

Three-phase, 200 VAC

AC drive model CIMR-U□□□	0028	0042	0054	0068	0081	0104	0130	0154	0192	0248
Input current [A]^{*1} (ND rating)	25	38	49	62	74	95	118	140	175	226
Rated input capacity [kVA]^{*2} (ND rating)	12	17	22	28	34	43	54	64	80	103
Rated output current (100 % ED) [A]^{*3,4} (ND rating)	28	42	54	68	81	104	130	154	192	248
Overload tolerance^{*6}	HD rating: 150 % of rated output current for 60s ND rating: 120 % of rated output current for 60s (Derating may be required for applications that start and stop frequently)									
Carrier frequency	4 kHz (User adjustable up to 10 kHz. Derating may be required.)									
Max. output voltage [V]	Proportional to input voltage ^{*5,7}									
Max. output frequency [Hz]	400 Hz (User-adjustable)									
Rated voltage rated frequency	Three-phase 200 to 240 VAC 50/60 Hz									
Allowable voltage fluctuation	-15 to +10 %									
Allowable frequency fluctuation	±3 % (Frequency fluctuation rate: 1 Hz/100 ms or less)									
Allowable phase power supply voltage unbalance	2 % or less									
Harmonic current harmonic distortion^{*5}	5 % or less (IEEE519 compliant)									
Input power factor	0.98 % or more (During rated operation)									

^{*1} Assumes operation at the rated output current. Input current rating varies depending on the power supply transformer, input reactor, wiring connections, and power supply impedance.

^{*2} Rated input capacity is calculated with a power line voltage of 240 V × 1.1.

^{*3} The rated output current of the drive output amps should be equal to or greater than the motor rated current.

^{*4} Carrier frequency is set to 4 kHz. Current derating is required to raise the carrier frequency.

^{*5} If the harmonic current distortion is needed to be 5 % or less, the maximum output voltage = [input voltage] × 0.87.

^{*6} C7-60 (Output Voltage Limit Mode Selection) is set to 0 (Harmonic Suppression Priority Mode).

^{*7} Heat stress generated from repetitive high current that exceeds 150% of the rated output current can shorten the life span of the IGBTs.

^{*8} The maximum output voltage = [input voltage] × 0.92.

^{*9} C7-60 (Output Voltage Limit Mode Selection) is set to 1 (Harmonic Suppression Priority Mode).

Model code

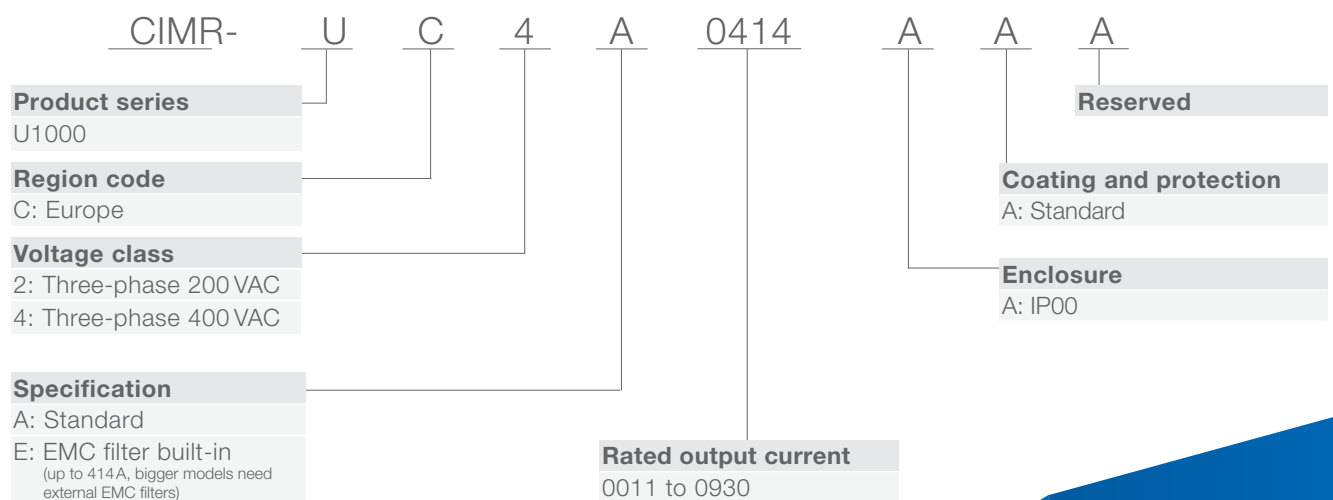

Technical specification

Drive functions

Control functions	
Control methods	V/f Control (V/f), V/f Control with PG (V/f w/PG), Open Loop Vector Control (OLV), Closed Loop Vector Control (CLV), Open Loop Vector Control for PM (OLV/PM), Advanced Open Loop Vector Control for PM (AOLV/PM), Closed Loop Vector Control for PM (CLV/PM)
Frequency control range	0.01 to 400Hz
Frequency accuracy (Temperature fluctuation)	Digital input: within ± 0.01 % of the max. output frequency (-10 °C to +40 °C) Analog input: within ± 0.1 % of the max. output frequency (25 °C ± 10 °C)
Frequency setting resolution	Digital input: 0.01 Hz Analog input: 1/2048 of the maximum output speed setting (11 bit plus sign)
Output speed resolution	0.001 Hz
Frequency setting signal	Main speed frequency reference: DC -10 to +10V (20k Ω), DC 0 to +10V (20k Ω), 4 to 20mA (250 Ω), 0 to 20mA (250 Ω) Main speed reference: Pulse train input (max. 32 kHz)
Starting torque	150 % at 3Hz (V/f, V/f w/PG), 200 % at 0.3Hz (OLV) 200 % at 0r/min (CLV, AOLV/PM, CLV/PM) 100 % at 3Hz (OLV/PM)
Speed control range	1:40 (V/f, V/f w/PG), 1:200 (OLV) 1:1500 (CLV, CLV/PM) ¹ 1:20 (OLV/PM), 1:100 (AOLV/PM)
Speed control accuracy	OLV: ± 0.2 % (25 °C ± 10 °C) ² CLV: ± 0.02 % (25 °C ± 10 °C) ²
Speed response	OLV: 10 Hz (25 °C ± 10 °C) CLV: 250 Hz (25 °C ± 10 °C)
Torque limit	Parameters setting allow separate limits in four quadrants (available in OLV, CLV, AOLV/PM, CLV/PM)
Accel/Decel time	0.0 to 6000.0s (4 selectable combinations of independent acceleration and deceleration settings)
Braking torque	Same value as overload tolerance
Main control functions	Torque Control, Droop Control, Speed/torque Control Switching, Feed Forward Control, Zero Servo Function, Momentary Power Loss Ride-Thru, Speed Search, Synchronous Transfer with Commercial Power Supply, Overtorque/Undertorque Detection, Torque Limit, 17 Step Speed (max), Accel/decel Switch, S-curve Accel/decel, 3-wire Sequence, Auto-tuning (rotational, stationary tuning), Dwell, Cooling Fan on/off Switch, Slip Compensation, Torque Compensation, Frequency Jump, Upper/lower Limits for Frequency Reference, DC Injection Braking at Start and Stop, PID Control (with sleep function), Energy Saving Control, MEMOBUS/Modbus Comm. (RS-422/RS-485 max, 115.2 kbps), Fault Restart, Application Presets, DriveWorksEZ (customized function), Removable Terminal Block with Parameter Backup Function, Online Tuning, Overexcitation Deceleration, Inertia (ASR) Tuning, High Frequency Injection, etc.
Protection functions	
Power supply regeneration	Available
Motor protection	Electronic thermal overload relay
Momentary overcurrent protection	Drive stops when output current reaches about 200 % of the rated current
Overload protection	Drive stops after 60 s at 150% of rated heavy duty output current ³
Overvoltage protection	200 V class: Stops when input voltage exceeds approx. 315 V 400 V class: Stops when input voltage exceeds approx. 630 V
Undervoltage protection	200 V class: Stops when input voltage falls below approx. 150 V 400 V class: Stops when input voltage falls below approx. 300 V
Momentary power loss ride-thru	Immediately stop after 2 ms or longer power loss ⁴ Continuous operation during power loss up to 2 s (standard) ⁵
Ground protection	Electronic circuit protection ⁶
Operating environment	
Area of use	Indoors
Ambient temperature	-10 °C to +50 °C (IP00 enclosure) -10 °C to +40 °C (IP20/UL Type 1 enclosure)
Humidity	95 % RH or less (non-condensing)
Storage temperature	-20 °C to +60 °C (short-term temperature during transportation)
Altitude	Max. 1,000m (max. 3,000m with output current and voltage derating)
Standards	UL508C, IEC/EN 61800-3, IEC/EN 61800-5-1, EN ISO 13849-1 Cat.3 PLe, IEC/EN 61508 SIL3, Marine (BV, NK, Lloyd's, DNV-GL, KR, ABS)
Environmental conditions	Class 3CS (chemical gases), Class 3S2 (solid particles)

¹ Current derating is required. Select control modes in accordance with the drive capacity.

² The accuracy of these values depends on motor characteristics, ambient conditions, and drive settings. Specifications may vary with different motors and with changing motor temperature. Contact Yaskawa for consultation.

³ Overload protection may be triggered when operating with 150% of the rated output current if the output frequency is less than 6 Hz.

⁴ May be shorter due to load conditions and motor speed.

⁵ A separate Momentary Power Loss Ride-Thru Unit is required for the drives if the application needs to continue running during a momentary power loss up to 2 s.

⁶ Ground protection cannot be provided when the impedance of the ground fault path is too low, or when the drive is powered up while a ground fault is present at the output.



Dimensions

up to 590 A rated current

IP00

Three-phase, 200 VAC

CIMR-	A	B	C	kg	kg without EMC filter
UC2□028AAA	250	360	480	21	20
UC2□042AAA	264	420	650	33	32
UC2□054AAA	264	420	650	33	32
UC2□068AAA	264	420	650	36	35
UC2□081AAA	264	420	650	36	35
UC2□104AAA	264	450	816	63	60
UC2□130AAA	264	450	816	63	60
UC2□154AAA	415	403	990	115	110
UC2□192AAA	415	403	990	115	110
UC2□248AAA	490	450	1,132	181	176

Three-phase, 400 VAC

CIMR-	A	B	C	kg	kg without EMC filter
UC4□011AAA	250	360	480	21	20
UC4□014AAA	250	360	480	21	20
UC4□021AAA	250	360	480	21	20
UC4□027AAA	250	360	480	21	20
UC4□034AAA	250	360	480	21	20
UC4□040AAA	264	420	650	33	32
UC4□052AAA	264	420	650	33	32
UC4□065AAA	264	420	650	36	35
UC4□077AAA	264	420	650	36	35
UC4□096AAA	264	450	816	63	60
UC4□124AAA	264	450	816	63	60
UC4□156AAA	415	403	990	115	110
UC4□180AAA	415	403	990	115	110
UC4□216AAA	490	450	1,132	181	176
UC4□240AAA	490	450	1,132	181	176
UC4□302AAA	695	450	1,132	267	259
UC4□361AAA	695	450	1,132	267	259
UC4□414AAA	695	450	1,132	267	259
UC4□477AAB*1	1,070	445	1,595	560*1	560
UC4□590AAB*1	1,070	445	1,595	560*1	560

*1 External EMC filter needs to be installed.



External EMC filter 400 V

Model Number		A	B	C	kg
CIMR-	EMC filter				
UC40477AAB	B84143B1000S080	410	260	140	18.5
UC40590AAB					

Connection diagram

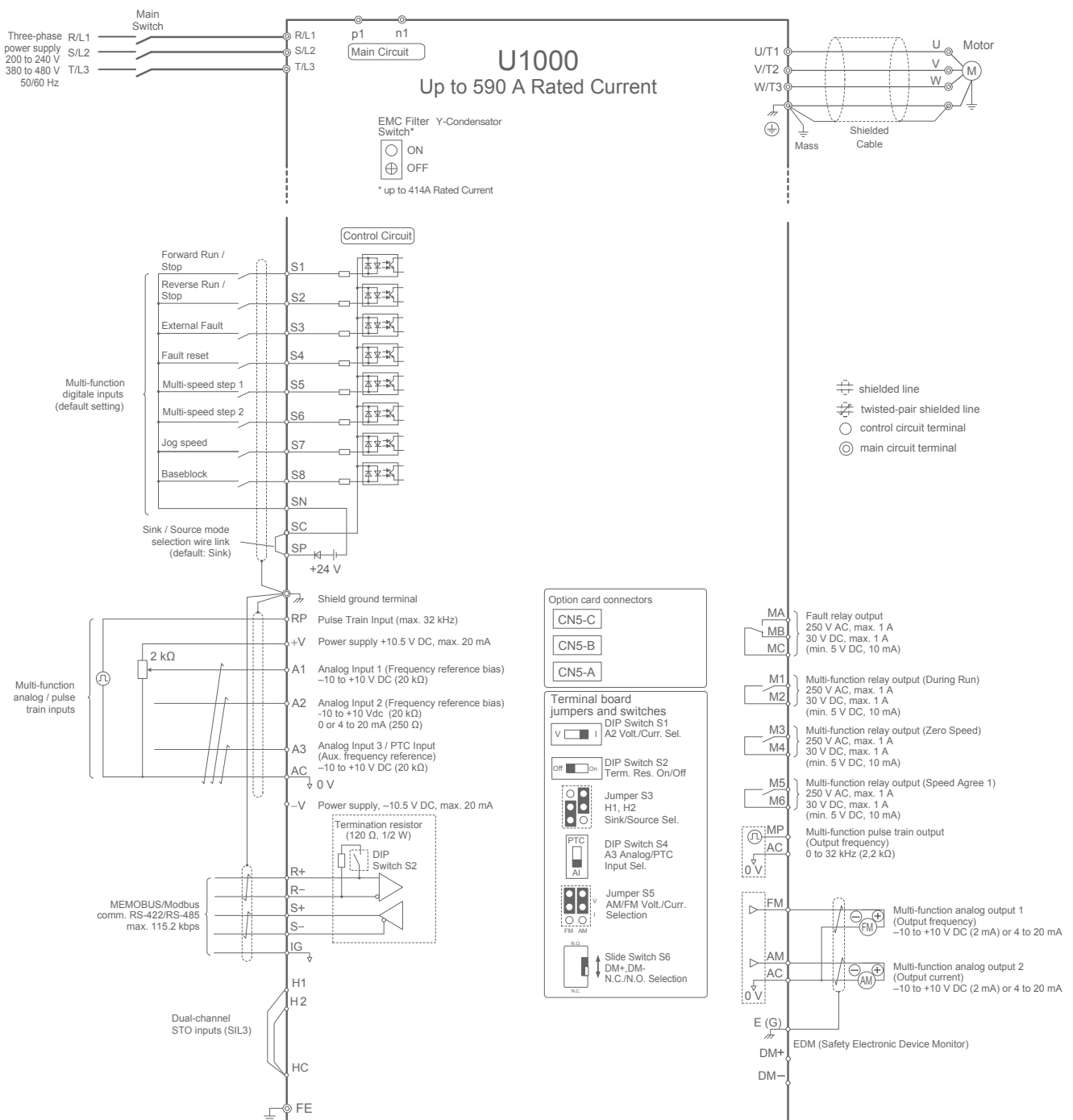

Dimensions

720 A rated current and above

IP00

Three-phase, 400 VAC

CIMR-	A	B	C	kg	kg without EMC filter
UC4□720AAB*1,2	1,210	445	1,835	630*1,2	630
UC4□900AAB*1,2	1,210	445	1,835	630*1,2	630
UC4□930AAB*1,2	1,210	445	1,835	630*1,2	630

*1 External EMC filter needs to be installed.

*2 External LC filter needs to be installed.

External LC filter module 400 V

Model Number		A	B	C	kg
CIMR-	LC filter				
UC4□720AAB	EUJ711830	700	432	1,350	345
UC4□900AAB	EUJ711840				
UC4□930AAB	EUJ711850				

External EMC filter 400 V

Model Number		A	B	C	kg
CIMR-	EMC filter				
UC4□477AAB	B84143B1000S080	410	260	140	18.5
UC4□590AAB					
UC4□720AAB	B84143B1600S080	490	260	140	24.5
UC4□900AAB					
UC4□930AAB					



Connection diagram

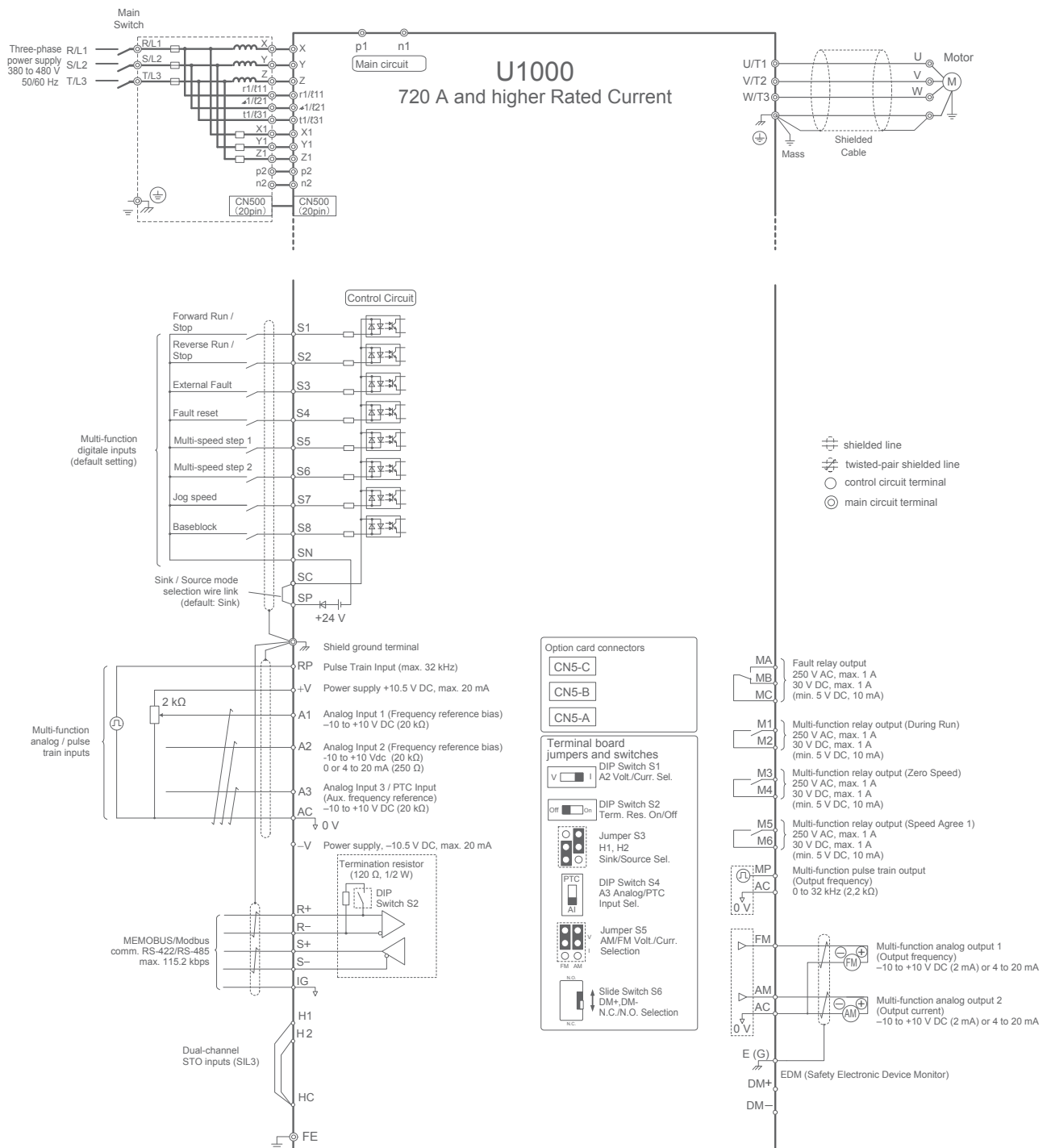

Options

The U1000 is a highly customizable product with many options to fit your specific requirements.

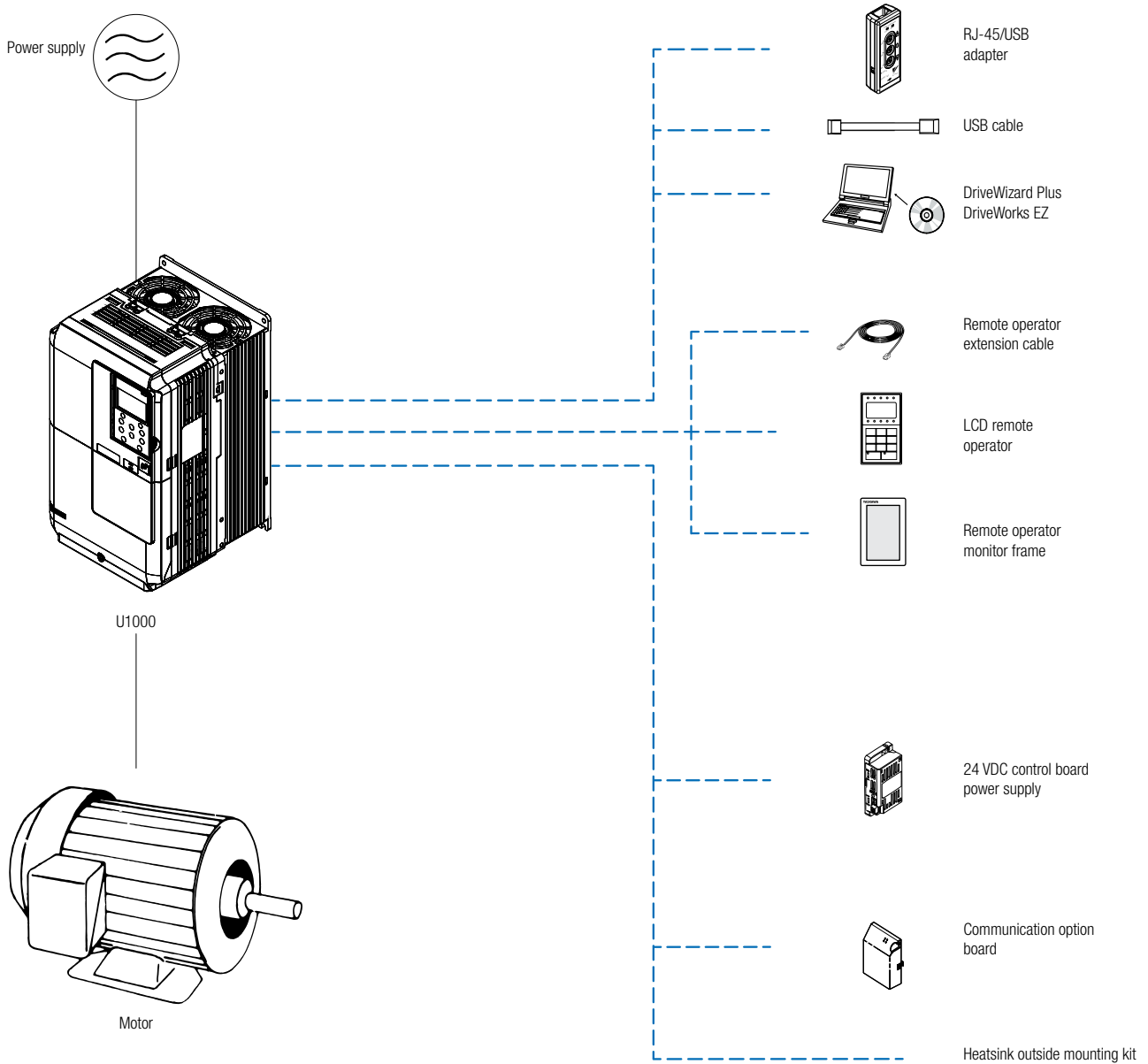

I/O interface options

Model code	Description
AI-A3	Analog input card (3 inputs)
AO-A3	2 additional analog output
DI-A3	Digital input (BCD Code)
DO-A3	Digital output (6 open collector 2 relays)

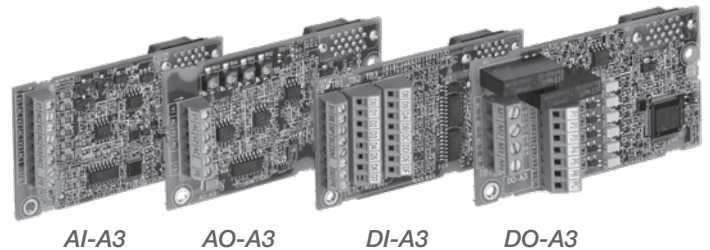

Communication option cards

Communication option cards connect a drive to a network. Using this option unit, a master device can:

- Operate the drive
- Monitor the drive operation status
- Read or modify drive parameters

Model code	Communication option type
SI-C3	CCLink
SI-EL3	Powerlink
SI-EN3	EtherNet IP
SI-EN3D	Dual Port EtherNet IP
SI-EM3	Modbus TCP
SI-EM3D	Dual Port Modbus TCP
SI-EP3	ProfiNet
SI-ES3	EtherCAT
SI-N3	DeviceNET
SI-P3	ProfibusDP
SI-S3	CANopen
SI-T3	MECHATROLINK-II

24 V power control supply

Model code	Description
PS-U10H	PS-U10H OP PWR.SPLY-CARD, 24V, 400V



NEMA 1 kit

Model code	Description
EZZ022745A	for 400V 11A, 14A, 21A, 27A, 34A for 200V 28A
EZZ022745B	for 400V 40A, 52A, 65A, 77A for 200V 42A, 54A, 68A, 81A
EZZ022745C	for 400V 96A, 124A for 200V 104A, 130A
EZZ022745D	for 400V 156A, 180A for 200V 154A, 192A
EZZ022745E	for 400V 216A, 240A for 200V 248A
EZZ022745F	for 400V 302A, 361A, 414A

Motor speed feedback options

Model code	Description
PG-B3	Open collector PG-interface 50kHz
PG-X3	Line driver PG-interface 300kHz
PG-F3	EnDat encoder interface card
PG-RT3	Resolver interface card

Digital operator options

Practical keypad, usable for remote operation.
Built-in parameter copy function.
For cabinet door mounting use EUOP-V11001

5 digit, 8 segment LED operator JVOP-182:

- Good readability from distance and in dark environment

Full text LCD keypad JVOP-180:

- Up to 13 languages



JVOP-180



JVOP-182

Model code	Description
EZZ020642A	Operator attachment IP20 with screws
EZZ020642B	Operator attachment IP20 with nuts
JVOP-180	LCD operator 1000 series (standard in U1000 included)
JVOP-182	LED operator 1000 series
EUOP-V11001	IP54/65 LCD/LED operator mounting frame
JVOP-181	Copy unit w/USB converter
WV001-YEG	1 m extension cable for remote digital operator
WV003-YEG	3 m extension cable for remote digital operator



JVOP-181

Handy copy unit for drive parameters.

- Copy/verify parameter settings between drives easily
- Usable as USB converter for connection to a PC
- Memorize parameter settings, archive them on a PC later

Application notes

Drive duty modes

Yaskawa AC drives have two duty modes from which a customer can select the application: Heavy Duty (HD) or Normal Duty (ND).

Duty mode*	Application	AC drive overload capability
Heavy duty	Constant torque or high starting torque <ul style="list-style-type: none">• Extruder• Mixer• Compressor• Conveyor• Crusher• Mill• Hoist	150% rated AC drive output current for 60 seconds
Normal duty	Variable (square) torque <ul style="list-style-type: none">• Fan• Pump• Blower	120% rated AC drive output current for 60 seconds

* Differences between HD ratings and ND ratings for the drive include rated input and output current, overload capacity, carrier frequency and current limit.

Peripheral devices

Magnetic contactor for input power

Use a magnetic contactor (MC) to ensure that power to the drive can be completely shut off when necessary. Even though an MC is designed to switch following a momentary power loss, frequent MC use can damage components in the drive. Avoid switching the MC more than once every 30 minutes.

Magnetic contactor for motor

As a general principle, the user should avoid opening and closing the magnetic contactor during run. Doing so can cause high peak currents and overcurrent faults. If magnetic contactors are used to bypass the drive by connecting the motor to the power supply directly, make sure to close the bypass only after the drive is stopped and fully disconnected from the motor.

Improving the power factor

Installing a DC or AC reactor to the input side of the drive can help improve the power factor.

Selection

Drive capacity

When running multiple induction motors in parallel using a single drive, the capacity of the drive should be larger than 1.1 times the total motor rated current. Use V/f control when running multiple induction motors using a single drive.

Starting torque

The overload current rating of the drive determines the starting and acceleration characteristics of the motor. Generally, lower torque characteristics on starting are expected when compared to using a commercial power supply. For applications that require high starting torque, select an drive with a larger capacity.

Emergency stop

When the drive faults out, a protective function is activated and drive output is shut off. This does not stop the motor immediately. Some type of mechanical brake may be needed if it is necessary to stop the motor faster than the Fast Stop function is able to do.

Settings

Upper limits

The drive is capable to run the motor up to 400 Hz. Incorrect settings might result in dangerous operating conditions, so be sure to set the upper limit for the frequency to control the maximum speed. (The maximum output frequency for operation by external input signals is set to 50 Hz by default.)

Accel/Decel times

Accel and decel times are determined by the torque that the motor generates, the load torque and the inertia moment (GD²). When the stall prevention function is activated, the accel/decel time might be extended to ensure motor control and prevents the motor from stalling. To achieve even faster acceleration and deceleration, select motors, and a drive, with greater capacity.

General handling

Compliance with local laws

Please comply with the law of the relevant country when you install this product.

Ambient environment

Keep the drive in a clean environment that is free from airborne oil mist, corrosive gas, flammable gas, lint and dust.

Wiring check

Never short the output terminals of the drive or apply voltage from the power supply to the output terminals (U, V, W). This will damage the drive. Carry out wiring that conforms to the wire sizes and tightening torques described in the Technical Manual. Make a wiring check to prevent wiring errors before turning the power on.

Inspection and maintenance

Make sure that the CHARGE light has gone off completely before performing any inspection or maintenance work. The heatsink of the drive can become quite hot during operation, and proper precautions should be taken to prevent burns. When replacing the cooling fan, shut off the power supply to the drive and wait at least 15 minutes before replacing the cooling fan.

Insulation tolerance

Consider voltage tolerance levels and insulation in applications with high input voltage or particularly long wiring distances.

High speed operation

Running a motor beyond its rated speed may lead to problems imposed by vibration or the durability of motor bearings. Contact the manufacturer of the motor for details.

YASKAWA Europe GmbH

Philipp-Reis-Str. 6
65795 Hattersheim am Main
Germany

+49 6196 569-500
support@yaskawa.eu
www.yaskawa.eu.com

11/2019
YEU_INV_U1000_EN_v3

Specifications are subject to change without notice for ongoing product modifications and improvements. © YASKAWA Europe GmbH. All rights reserved.

YASKAWA